

# KODA™

## MOTION ACTIVATED LED SECURITY FLOODLIGHT

ITM. / ART. 1671550  
Model: LM030412

### CARE & USE INSTRUCTIONS

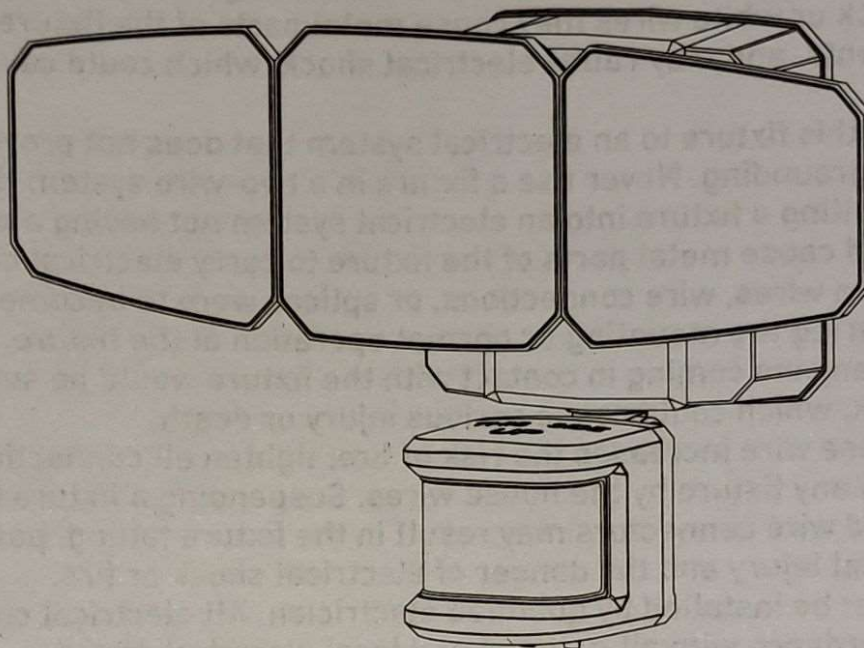

@KodaBuiltOfficial

**IMPORTANT INFORMATION.  
PLEASE READ CAREFULLY AND RETAIN  
FOR FUTURE REFERENCE.**

For assistance with assembly, installation, parts or customer service,  
please contact us:



info@kodabuilt.com



1-866-294-9244, Monday to Friday, 8am to 5pm Pacific Time



2975 Red Hill Ave., Suite 100, Costa Mesa, CA 92626, USA

## **IMPORTANT SAFETY INSTRUCTIONS:**

Please read the following safety information before attempting to assemble, operate or install the product. To reduce risk of fire, electric shock, or injury to persons:

- CAUTION:** Turn OFF the main power at the fuse or circuit breaker before installing the lighting fixture or making any electrical connection. Failure to do so may result in serious injury or death.
- **CAUTION:** Consult a qualified electrician to ensure correct branch circuit conductor.
  - **WARNING:** If any special control devices are used with this fixture, follow instructions carefully to assure full compliance with N.E.C. requirements. If there are any questions, contact a qualified electrical contractor.
  - Make sure this lighting fixture is adequately grounded. Do not connect the bare or green insulation fixture ground wire to the black (hot) current-carrying wire or the white (neutral) wire. Connection of the bare or green fixture ground wire to the black or white wires may cause metal parts of the fixture to carry electrical currents, and may cause electrical shock, which could cause serious injury or death.
  - Do not connect this fixture to an electrical system that does not provide a means for equipment grounding. Never use a fixture in a two-wire system that is not grounded. Installing a fixture into an electrical system not having a proper grounding could cause metal parts of the fixture to carry electrical currents if any of the fixture wires, wire connections, or splices were to become broken, cut, or loose during the mounting or normal operation of the fixture. Under this condition, anyone coming in contact with the fixture would be subject to electrical shock, which could cause serious injury or death.
  - **CAUTION:** A loose wire increases the risk of fire; tighten all connections securely.
  - Do not suspend any fixture by the house wires. Suspending a fixture by the house wires and wire connectors may result in the fixture falling, possibly causing personal injury and the danger of electrical shock or fire.
  - The fixture must be installed by qualified electrician. All electrical connections must be in accordance with all national and local electrical codes.
  - Do not mount the unit against flammable surfaces.
  - The motion detector will not operate properly if it is installed:
    - Near the outlet of a central heating boiler
    - Near an air conditioning unit
    - Pointing directly at moving vehicles
    - Near another light that is shining its light, or causing a reflection, on the motion detector.
  - This fixture cannot be used with a dimmer switch, motion or occupancy sensor, and other electronic switching devices unless otherwise designated. LED fixtures must be powered directly off a switch circuit.
  - This fixture should not be used in areas with limited ventilation or high ambient temperatures.
  - This fixture is intended to be connected to a properly installed and grounded NEC compliant outlet box.
  - LED light output is strong enough to injure human eyes. Precautions must be taken to prevent looking directly at the LEDs for more than a few seconds.

- Do not tamper with or attempt to repair the LED component or fixture. The light source is designed for this specific application and should not be serviced by untrained personnel. Contact the KODA Customer Service team if any servicing is required.
- Do not exceed fixture's maximum ambient temperatures.
- This fixture is designed for use in a 120VAC, 60Hz fuse circuit.
- For outdoor use.

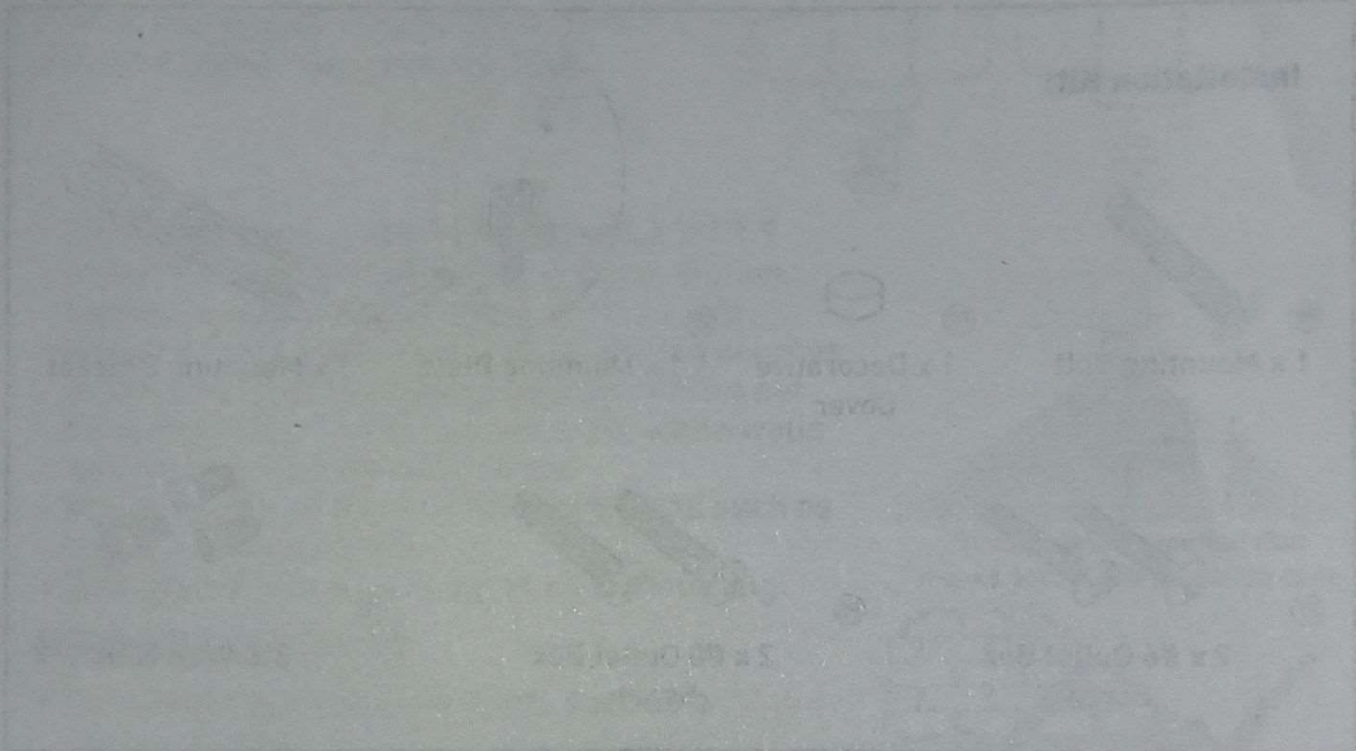

Tools Needed for Assembly

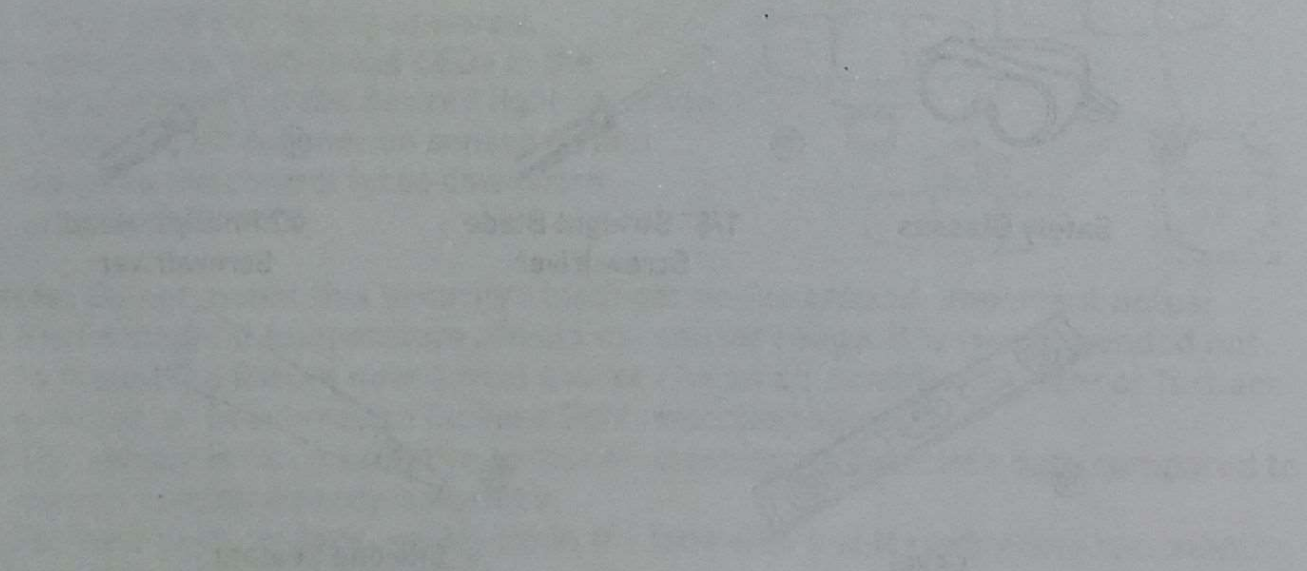

# PACKAGE CONTENTS:

Please lay out all parts and read the instructions prior to installation.

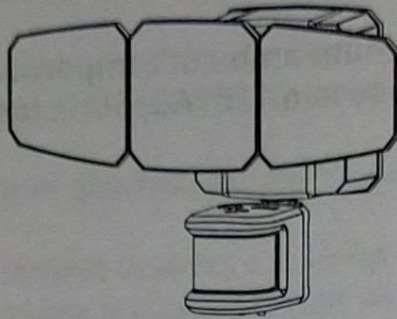

PA

1 x Motion Activated LED Security Floodlight

## Installation Kit:

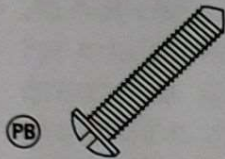

PB

1 x Mounting Bolt

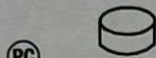

PC

1 x Decorative Cover

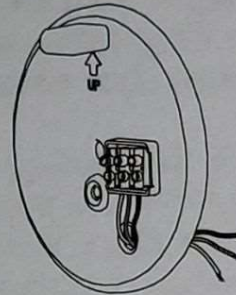

PD

1 x Mounting Plate

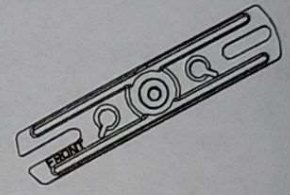

PE

1 x Mounting Bracket



PF

2 x #6 Outlet Box Screw

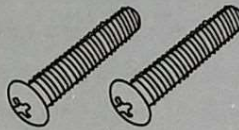

PG

2 x #8 Outlet Box Screw

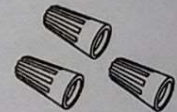

PH

3 x Wire Nut

## Tools Needed (not included)



TA

Safety Glasses

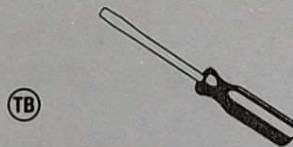

TB

1/8" Straight Blade Screwdriver

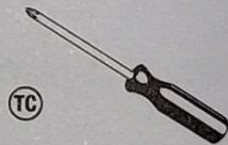

TC

#2 Phillips-Head Screwdriver

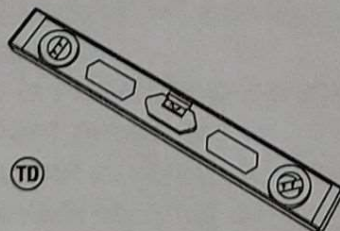

TD

Level

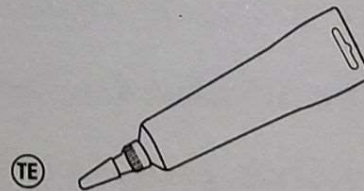

TE

Silicone Sealant

## PRODUCT SPECIFICATIONS:

1. Operating Voltage: 120 Vac, 60 Hz
2. Wattage: 44 W
3. Light Output: 3600 lumens
4. Color Temperature: 5000K
5. LED Life Cycles: up to 50,000 hours
6. Operating Temperature:  $-20^{\circ}\text{C}$  to  $40^{\circ}\text{C}$  /  $-4^{\circ}\text{F}$  to  $104^{\circ}\text{F}$

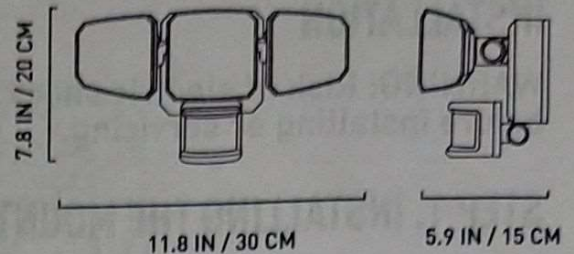

## INSTALLATION PROCEDURES:

Before beginning assembly of the product, make sure all parts are present. Compare parts with package contents list. If any part is missing or damaged, do not attempt to assemble the product.

Before installation, rotate the motion sensor head to read "this side up".

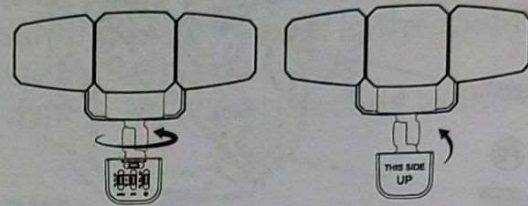

- Install the motion sensor between 6.2 ft / 1.9 m and 8.2 ft / 2.5 m above the ground. Motion sensor is less sensitive above 8.2 ft / 2.5 m.
- Mount sensor away from heat producing sources to prevent false triggering. Be very careful not to include objects such as windows, white walls and water in the detection zone.
- Mount fixture away from moving objects such as trees and street traffic.
- Suitable for wall mounting or eave mounting.

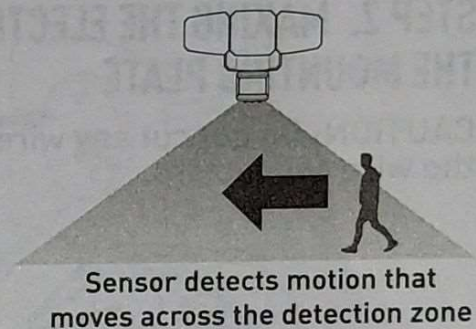

## MOUNTING LOCATIONS:

- Determine the mount location, such as a wall or eaves
- The motion sensor needs to be on the bottom and the light should have "THIS SIDE UP" facing upwards.
- Position the triple-head LEDs in the general direct of the desired light coverage.
- If needed, lift the motion sensor up and down so the control faces downward after installation.

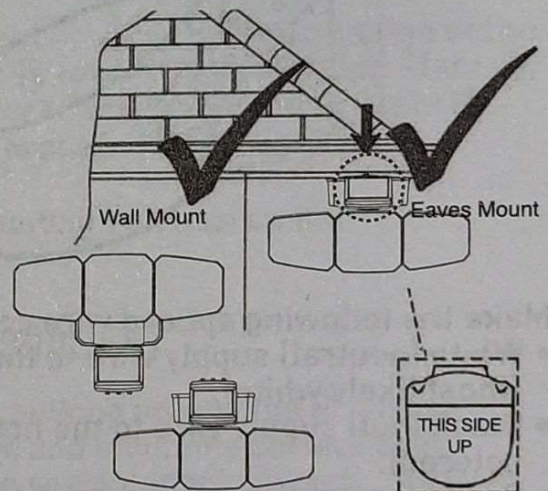

**Note:** Do not mount this Security Floodlight on the ground. Important notes:

1. Environmental temperature affects the sensor range. It is recommended not to mount the fixture near a heat source like an air conditioner, vent or furnace exhaust, or in a direction facing a light reflecting object.
2. The sensor is more sensitive to motion crossing its detection path compared to motion coming directly towards it.
3. For best performance, gently clean the lens with a soft cloth every two months to assure maximum sensitivity.

## INSTALLATION

**WARNING:** Risk of electric shock. Disconnect power at fuse or circuit breaker before installing or servicing.

### STEP 1. INSTALLING THE MOUNTING BRACKET

Line up the holes on the Mounting Bracket (PE) with the holes on your outlet box. Using the two Mounting Screws (PF) or (PG) fit the outlet box. Ensure the 'FRONT' marking is at the front after installation.

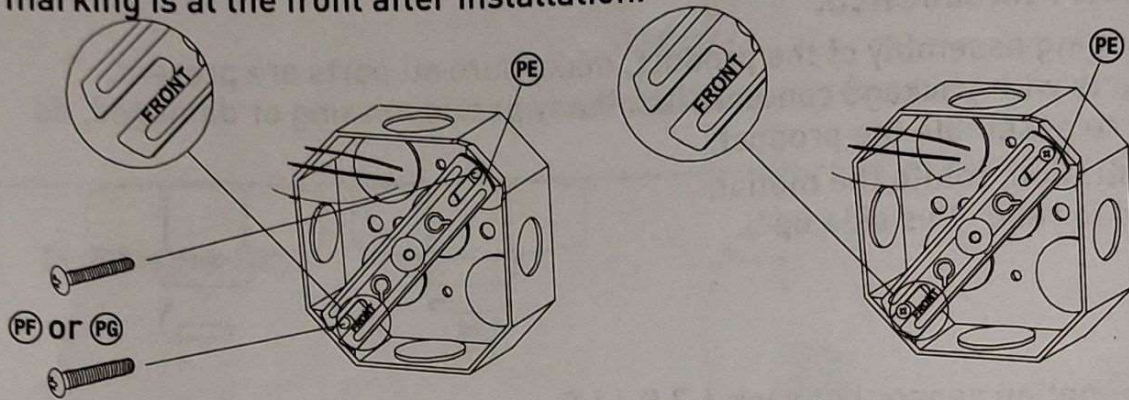

### STEP 2. MAKING THE ELECTRICAL CONNECTIONS AND INSTALLING THE MOUNTING PLATE

**CAUTION:** Do not cut any wires with factory installed wire connectors or remove the wire connectors.

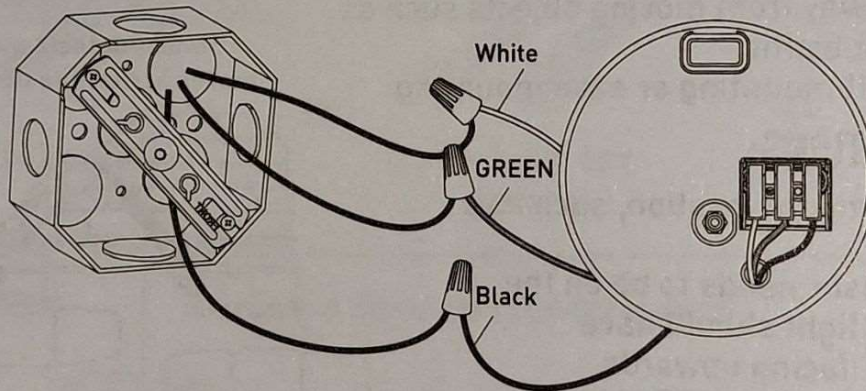

Make the following spliced wire connections using wire nuts:

- White (neutral) supply wire to the common/neutral wire from the outlet box (most likely white).
- Black (hot) supply wire to the hot wire from the outlet box (most likely black or colored).
- Green (ground) supply wire to the ground wire from the outlet box (most likely bare copper, green wire, or green and yellow wire), or wrap around the ground screw if ground wire does not exist.

Screw the wire nuts in a clockwise direction. Ensure no bare wire or wire strands are visible after making the connections.

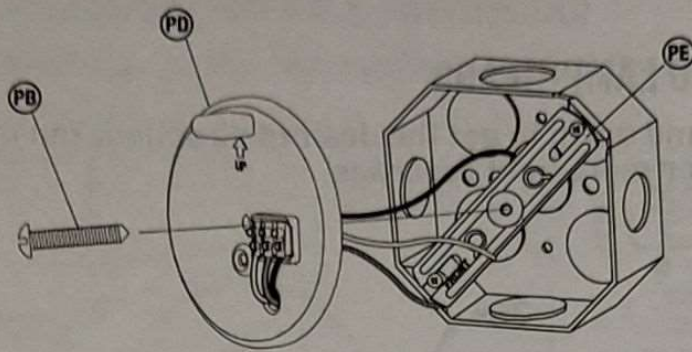

- Place the Mounting Plate (PD) against the outlet box.
- When mounting to a wall, the "UP" arrow must point upward.
- When mounting to eaves, the "UP" arrow must point toward the building.
- Insert the Mounting Bolt (PB) through the mounting plate (PD) hole in the middle, and Mounting Bracket (PE) hole. Tighten the Mounting Bolt (PB) securely.
- Firmly pull on the Mounting Plate (PD) to verify it is securely attached to the Mounting Bracket (PE).

### STEP 3. MOUNTING THE SECURITY FLOODLIGHT

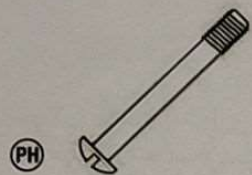

Large mounting bolt  
(pre-installed)

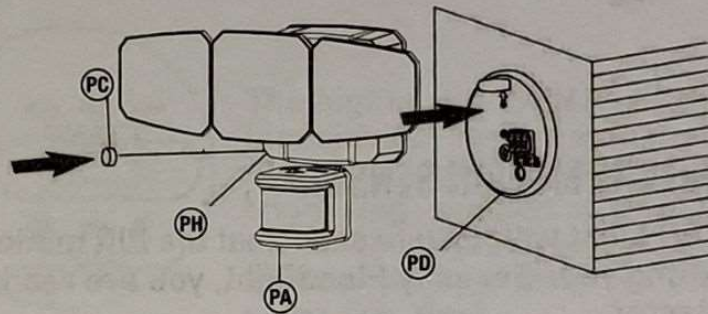

- Align the bottom edge of the Security Floodlight (PA) with the bottom edge of the Mounting Plate (PD). Tilt the Security Floodlight (PA) toward the Mounting Plate (PD), making sure the Security Floodlight (PA) is centered on the Mounting Plate (PD).
- Tighten the Large Mounting Bolt (PH) securely through the center of the Mounting Plate (PD). Do not overtighten.
- Push the Decorative Cover (PC) firmly into the mounting bolt hole on the Security Floodlight (PA).

### STEP 4. CAULKING AROUND THE SECURITY FLOODLIGHT

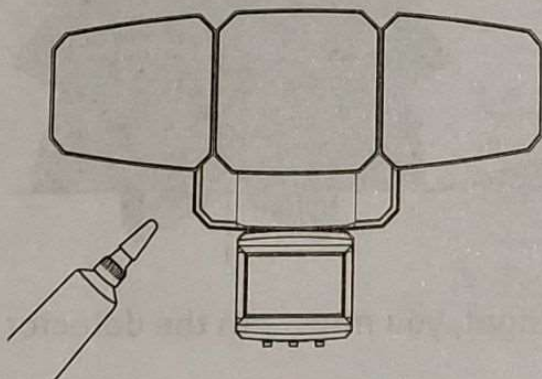

Apply caulk around the Mounting Plate (PD) and mounting surface with silicone sealant (not included).

## OPERATION

### 1. ADJUSTING THE LED LAMP-HEADS

Adjust the lamp up and down to get the desired direction. You may also turn the side panels to side for more light coverage.

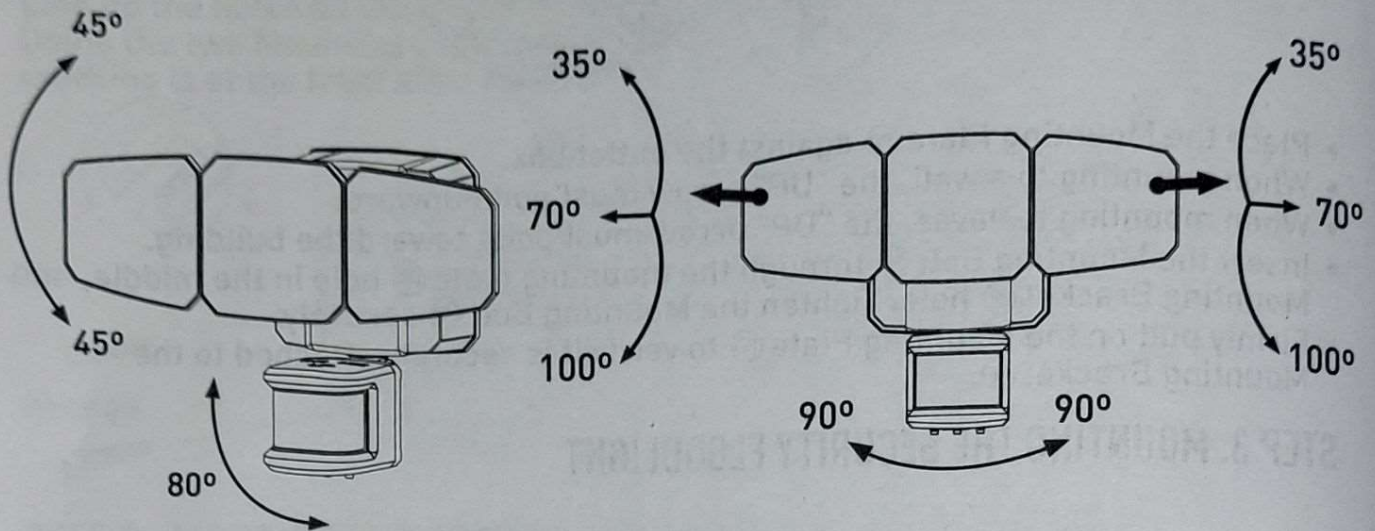

### 2. ADJUSTING THE MOTION SENSOR

- The Blue LED Light will flash to show that the PIR motion sensor is functioning properly.
- After installing your Security Floodlight, you are ready to set /aim the motion detector.
- Detection Range: around 70 ft / 21.3 m x 240° (Max)
- 70 ft / 21.3 m detection range, it upon on ambient temperature 25°C / 77°F.
- Adjust the sensor head horizontal for long coverage.

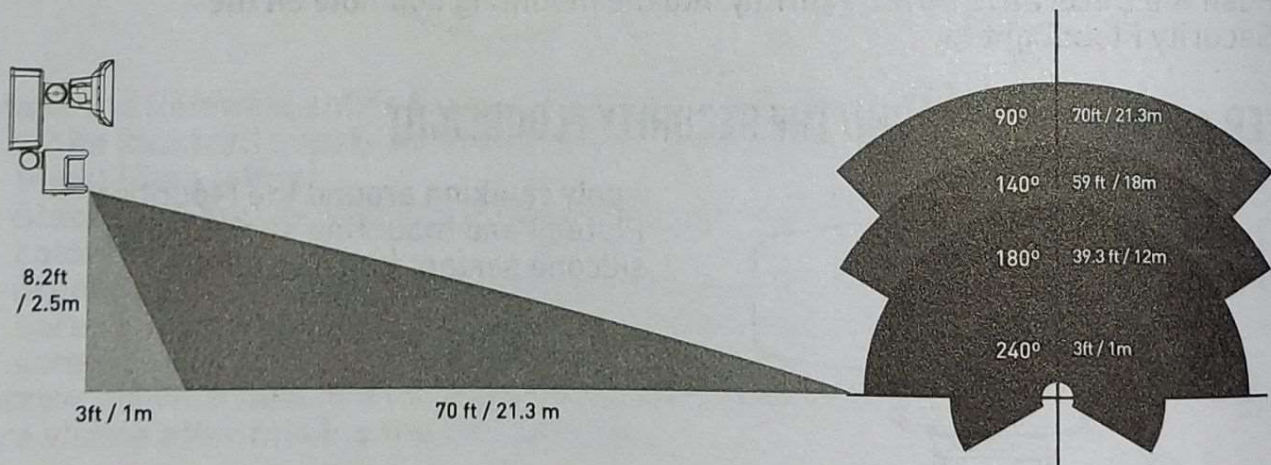

Note: When you first install your Security Floodlight, you must aim the detector head to cover the desired area.



### 3. ROTATING THE SENSOR CONTROLS DOWNWARD

Rotate the motion sensor so the controls face toward the ground.

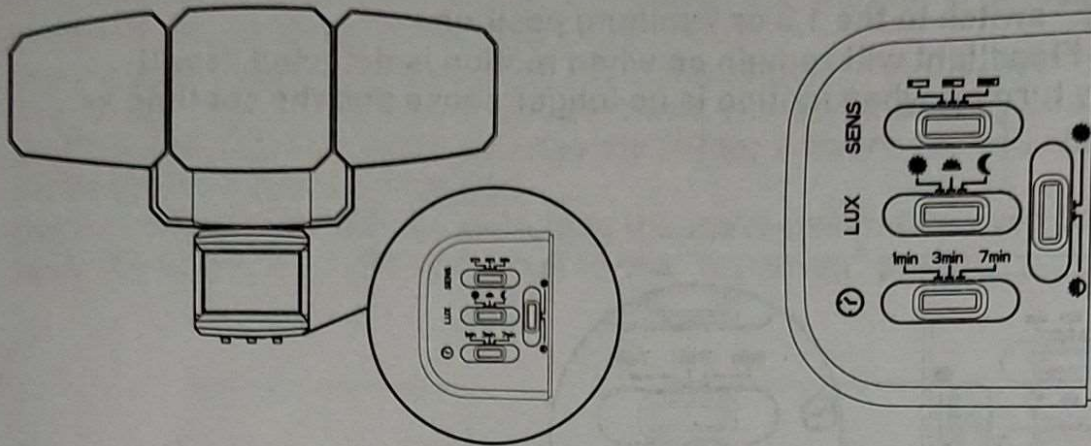

#### Sensor Detection Range (SENS) Switch

Adjust the SENS setting to adjust range of Passive Infrared (PIR) Motion Sensor

- Slide the "SENS" switch toward the ☐ (low) position for short detection range.
- Slide the "SENS" switch toward the ▣ (middle) position for middle detection range.
- Slide the "SENS" switch toward the ▤ (high) position for long detection range.

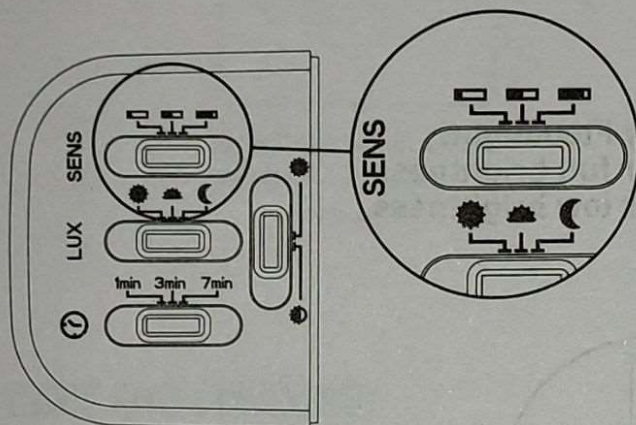

The higher the "SENS" setting (sensitivity), the greater the possibility of false triggering. To reduce false triggering, suggest to slide the "SENS" switch toward the ☐ (low) setting if you don't need long detection distance while using this light.

#### Dusk Level / Ambient Light sensor (LUX) Setting

This setting is used to control when the security light will be activated relative to the ambient natural light.

- When sliding the "LUX" switch toward the ☀ position, the light will turn on in the daylight, sunset, or in darkness.
- When sliding the "LUX" switch toward the 🌇 position, the light will turn on at sunset or in the darkness.
- When sliding the "LUX" switch toward the 🌑 position, the light will only turn on in the darkness.

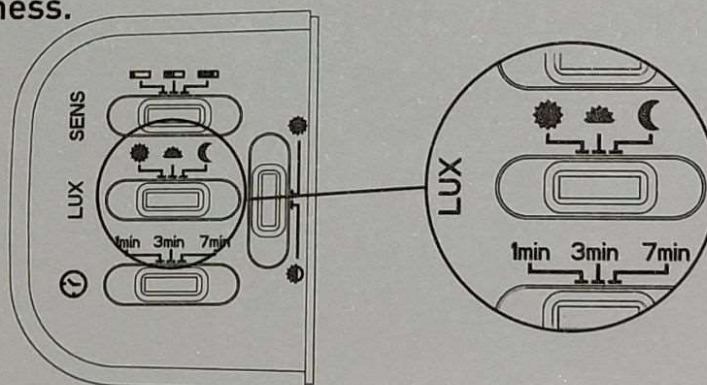

## Time Setting ⌚

Adjust the timer for how long the Security Floodlight will be activated when motion is detected.

- Set the "TIME" switch to the 1,3 or 7 minute position.
- The Security Floodlight will remain on when motion is detected. It will automatically turn off when motion is no longer sense and the set time as expired.

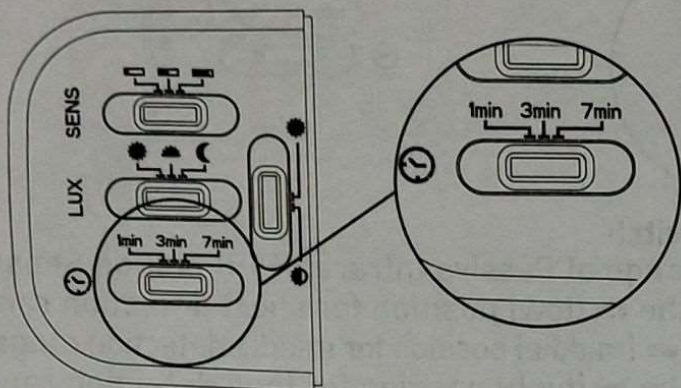

## Brightness Setting ☀

- Adjust the brightness level of the Security Floodlight.
- Slide the switch towards the ☀ position for full brightness.
- Slide the switch towards the 🌙 position for low brightness.

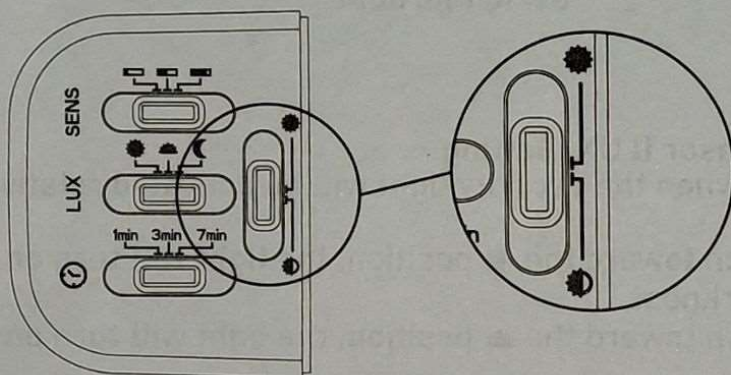

## 4. MANUAL OVERRIDE FUNCTION

- When power is on, the light enters a "warm-up" period for about 20 seconds, then automatically switches into AUTO MODE.
- During AUTO MODE, by switching the main switch OFF-ON-OFF-ON within 3 seconds, the light at sunset or darkness, will automatically change into MANUAL MODE. The lights will remain ON for 6 hours., or will change back to AUTO MODE if dawn is reached.
- During MANUAL MODE, by switching the main switch OFF over 10 seconds then back ON again, the light will reset to the "warm-up" period.

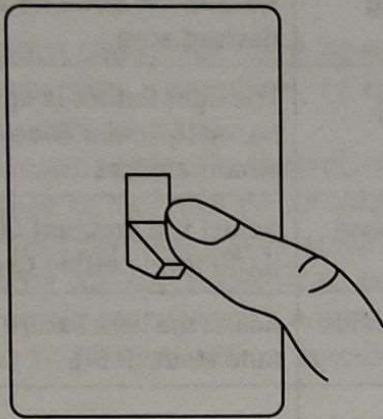

Turn the switch OFF-ON-OFF-ON within 3 seconds'

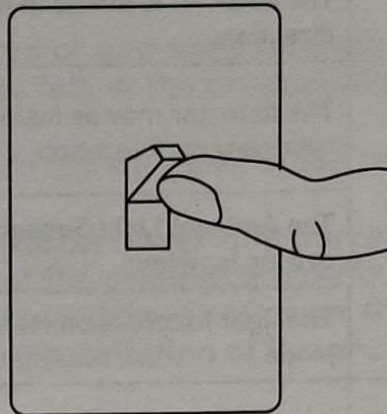

Turn the switch back ON

## CARE AND CLEANING:

- To prolong the original appearance, clean with clear water and a soft, damp cloth only.
- Do not use paints, solvents, or other chemicals on this light fixture. They could cause a premature deterioration of the finish. This is not a defect in the finish and will not be covered by the warranty.
- Do not spray with a hose or power washer.

## TROUBLESHOOTING:

PROBLEM	POSSIBLE CAUSE	SOLUTION
The light will not come on.	The light wall switch is turned off.	Turn the light wall switch on.
	The fuse is blown or the circuit breaker is turned off.	Replace the fuse or ensure the circuit breaker is in the on position.
	Faulty wire connection.	Check wiring to ensure all wires are correctly wired and are wired securely.
	The detector is aimed in the wrong direction.	Re-aim the detector to cover the desired area.
The light comes on during the day.	The detector may be installed in a relatively dark location.	The light fixture is operating normally under these circumstances.
	The Ambient Light Sensor (LUX) level setting is wrong.	Adjust the Ambient Light Sensor (LUX) level setting to $\curvearrowright$ position.
	The light fixture is on Manual Override Mode.	Adjust the light fixture to Auto Mode (P.11).
The lights stay on continuously.	A bulb is positioned too close to the detector or pointed at nearby objects that cause heat to trigger the light detector.	Reposition the bulb away from the detector or nearby objects.
	The light fixture is on Manual Override Mode.	Adjust the light fixture to Auto Mode.
	The light fixture is on the same circuit as a motor, transformer, or fluorescent bulb.	Install the light fixture on a circuit without motors, transformers, or fluorescent bulbs. (Dedicated Circuit)
	Some home wires are not properly color coded.	Check for proper wiring.
The light comes on for no apparent reason.	There is motion in the detection zone.	Make sure the detector is not picking up moving objects such as trees, traffic, etc. and re-aim the detector.
	The light fixture is wired through a dimmer or timer.	Do not use a dimmer or timer to control the light fixture. Replace the dimmer or timer with a standard on/off wall switch.

## **WARRANTY:**

### **KODA**

This KODA product carries a 5-year warranty against defects in workmanship and materials subject to the conditions and additional warranty information available at: [www.kodabuilt.com/warranty](http://www.kodabuilt.com/warranty)

### **CONDITIONS OF WARRANTY**

If during the 5-year warranty period your new product is found to be defective, KODA will repair such defect, or replace the product, without charge for parts or labor subject to the following conditions:

- All repairs must be performed by KODA.
- All warranty claims must be accompanied by a copy of the sales receipt or bill of sale.
- The equipment must not have been altered or damaged through negligence, accident, improper operation, or failure to follow the product instructions for installation, use, or care.
- The replacement of parts is excluded from the warranty when replacement is necessary due to normal wear and tear.
- Repair or replacement parts supplied by KODA under this warranty are protected only for the unexpired portion of the original warranty.
- This is a "repair or replace" warranty only, and does not cover the costs incurred for the installation, removal or reinstallation of the product.

**OWNER'S RESPONSIBILITIES:** KODA will make every effort to provide warranty service within a reasonable period of time. **SHOULD YOU HAVE ANY QUESTIONS ABOUT SERVICE RECEIVED OR IF YOU WOULD LIKE ASSISTANCE IN OBTAINING SERVICE, PLEASE CALL TOLL FREE 1.866.294.9244 DURING REGULAR BUSINESS HOURS MONDAY THROUGH FRIDAY 8:00 AM TO 5:00PM PST.**

**NOTE:** Toll-free number is for North American customers **ONLY**. See customer service section for customer contact numbers for other regions/offices.

For customer service and technical support, please call us at 1.866.294.9244 or email us at [info@KODAbuilt.com](mailto:info@KODAbuilt.com). If at that time it is determined that a replacement unit is needed, the support representative will issue a Return Authorization and instruct on how to get a new unit.

KODA makes no other warranty of any kind aside from the limited express warranty stated herein.

**DISCLAIMER OF WARRANTIES, INCLUDING WARRANTY OF MERCHANTABILITY AND WARRANTY OF FITNESS FOR PARTICULAR PURPOSE: EXCEPT AS SPECIFICALLY SET FORTH HEREIN, NO WARRANTY OR REPRESENTATION, EXPRESS OR IMPLIED, IS MADE AS TO THE MOTION ACTIVATED LED SECURITY FLOODLIGHT. KODA AND/OR ITS AFFILIATES EXPRESSLY DISCLAIMS, WITHOUT LIMITATION, ANY STATUTORY WARRANTIES AND ALL IMPLIED WARRANTIES, INCLUDING ANY IMPLIED WARRANTY OF MERCHANTABILITY OR FITNESS FOR A PARTICULAR PURPOSE.**

## **FCC COMPLIANCE STATEMENT:**

**MOTION ACTIVATED LED SECURITY FLOODLIGHT**

Model: LM030412

Responsible Party:

Koda

Address: 2975 Red Hill Ave., Ste. 100, Costa Mesa, CA 92626, USA

Tel: 1-866-294-9244

This device complies with Part 15 of the FCC rules. Operation is subject to the following two conditions: (1) This device may not cause harmful interference, and (2) this device must accept any interference received, including interference that may cause undesired operation.

**Warning:** Changes or modifications to this unit not expressly approved by the party responsible for compliance could void the user's authority to operate the equipment.

The manufacturer is not responsible for any radio or TV interference caused by unauthorized modifications or change to this equipment. Such modifications or change could void the user's authority to operate the equipment.

**Note:** This equipment has been tested and found to comply with the limits for a Class B digital device, pursuant to part 15 of the FCC Rules. These limits are designed to provide reasonable protection against harmful interference in a residential installation. This equipment generates, uses and can radiate radio frequency energy and, if not installed and used in accordance with the instructions, may cause harmful interference to radio communications. However, there is no guarantee that interference will not occur in a particular installation. If this equipment does cause harmful interference to radio or television reception, which can be determined by turning the equipment off and on, the user is encouraged to try to correct the interference by one or more of the following measures:

- Reorient or relocate the receiving antenna.
- Increase the separation between the equipment and receiver.
- Connect the equipment into an outlet on a circuit different from that to which the receiver is connected.
- Consult the dealer or an experienced radio/TV technician for help.

Distributed by:  
Costco Wholesale Corporation  
P.O. Box 34535  
Seattle, WA 98124-1535  
USA  
1-800-774-2678  
www.costco.com

Importado por:  
Importadora Primex S.A de C.V.  
Blvd. Magnocentro No. 4  
San Fernando La Herradura  
Huixquilucan, Estado de México  
C.P.52765  
RFC: IPR-930907-S70  
(55)-5246-5500  
www.costco.com.mx

Costco Wholesale UK Ltd /  
Costco Online UK Ltd  
Hartspring Lane  
Watford, Herts  
WD25 8JS  
United Kingdom  
01923 213113  
www.costco.co.uk

Costco Wholesale Iceland ehf.  
Kauptún 3-7, 210 Gardabaer  
Iceland  
www.costco.is

Costco Wholesale Japan Ltd.  
2 Kakuchi, 2 Gaiku, Kaneda-Nishin  
361 Urikura, Kisarazu shin  
Chiba, 292-0007 Japan  
0570-200-800  
www.costco.co.jp

Costco Wholesale New Zealand Limited  
2 Gunton Drive  
Westgate  
Auckland 0814  
New Zealand  
www.costco.co.nz

Costco Wholesale Sweden AB  
Box 614  
114 11 Stockholm  
Sweden  
www.costco.se

Costco Wholesale Canada Ltd.\*  
415 W. Hunt Club Road  
Ottawa, Ontario  
K2E 1C5, Canada  
1-800-463-3783  
www.costco.ca  
\* faisant affaire au Québec sous le nom les  
Entrepôts Costco

Costco Wholesale Australia Pty Ltd  
17-21 Parramatta Road  
Lidcombe NSW 2141  
Australia  
www.costco.com.au

Costco Wholesale Spain S.L.U.  
Polígono Empresarial Los Gavilanes  
C/ Agustín de Betancourt, 17  
28906 Getafe (Madrid) España  
NIF: B86509460  
900 111 155  
www.costco.es

Costco France  
1 avenue de Bréhat  
91140 Villebon-sur-Yvette  
France  
01 80 45 01 10  
www.costco.fr

Costco Wholesale Korea, Ltd.  
40, ILiik-ro  
Gwangmyeong-si  
Gyeonggi-do, 14347, Korea  
1899-9900  
www.costco.co.kr

Costco (China) Investment Co., Ltd.  
Room 1003, Block 2, 2388 Xiupu Road,  
Pudong New Area, Shanghai  
China 201315  
+86-21-6257-7065

## MADE IN CAMBODIA

 Have a comment or question? Email us at [info@kodabuilt.com](mailto:info@kodabuilt.com) or visit us online at [www.KodaBuilt.com](http://www.KodaBuilt.com)

# KODA™

A Horizon Brands Company  
2975 Red Hill Ave., Ste. 100, Costa Mesa, CA 92626, USA | Tel: 1-866-294-9244  
© 2023 Koda. All rights reserved.